

# JouleStickKIT1

Product Specifications  
PS-JSKIT1-01/01-170616

The **JouleStickKIT1** is a solar lamp that contains a **JouleStick**, F50 detachable lamp, PicoLEC20 Solar Panel and BottleStand. The **JouleStick** with F50 lamp can be used as torchlight, hanging lamp, and at home you can insert it into the bottle stand and use it as a study lamp. The PicoLEC20 Solar Panel can harvest the new energy from the sun and refill your **JouleStick30** back to full in one day after its usage.



The BottleStand can be inserted in most common type of plastic PET water Bottles or Glass Bottle (the Bottle is not included in the package!). We recommend to fill the bottle with sand or small stones so that it can provide good stability when used as study lamp.

## Product HighLights

- The **Joulite30** contains 30kj of energy
- Fully charges a smart phone or 2 low feature phones
- Up to 24 hours on a full charge (F50 Lamp)
- Recharged via the PicoLEC20 Solar Panel
- Splash-Waterproof and is suitable for outdoor usage even in the rain
- Electrical contacts are completely sealed and no water can leak through the contacts to the inside of the lamp that houses the battery and electronic circuit

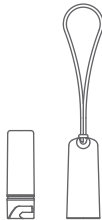

1x JouleStick30



F50 lamp

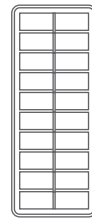

1x PicoLEC20

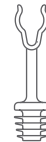

1x BottleStand

## Item Quantities in each kit

JouleStick30	1
F50 lamp	1
PicoLEC20	1
Bottle Stand	1

## Master Box Dimensions

Quantity per Master Box	12
Length	203 mm
Width	256 mm
Height	236 mm
Volume	12.3 liter
Mass	3.62 kg

## Retail Box Dimensions

Length	62 mm
Width	65 mm
Height	220 mm
Volume	0.88 liter
Mass	0.26 kg

# F50

**Product Specifications**  
PS-F50-01/01-220616

The F50 is a 50 Lumen output Light attachment for the JouleStick based on ultra efficient Light Emitting Diode Technology that can operate within a DC Voltage range of 3 up to 4.2 V. The F50 connects to the JouleStick through a unique and patented bayonet connection. The F50 has a highly diffused lens to give a non-glare and equally distributed light output that is safe for the eyes. The On-Off switching of the Light is done through rotation of the Light attachment



## F50 Performance (in combination with JouleStick30)

Maximum Light Output 50 Lumen  
LED Electricity to Light Conversion Efficiency 25%

Light Output and energy consumption in combination with JouleStick30:

Time	Light Output	Energy Use	
First 5 hours	50 Lumen	1.5 kJ/h	(0.42 W)
Next 10 hours	40 Lumen	1.2 kJ/h	(0.33 W)
Next 10 hours	30 Lumen	0.8 kJ/h	(0.22 W)
Last 5 hours	20 Lumen	0.5 kJ/h	(0.14 W)

Color Temperature 5000K (Cool White)  
LM-80 Lumen Maintenance 60,000 hours  
Operating Temperature 0-60 °C

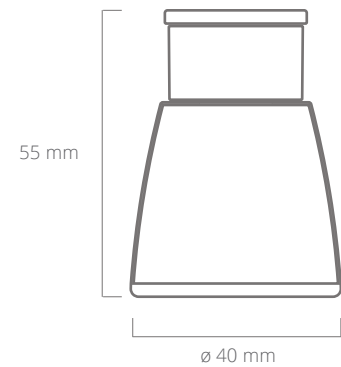

## Electrical Details

Safe Input Voltage Range 3 - 4.2 VDC  
Max Operating Current 138 mA (@4,17V)

## Mechanical and Environmental Details

Connector System Gold Plated Pogo Pin  
Enclosure Material UV Stabilized ABS  
Lens Material PC  
Color White  
Product Dimensions ø 40mm x 55mm Height  
Nett Product Weight 20 gr  
Packaging Options Individual Packing or as part of JouleStick kits  
Individual Box Dimension 42 x 42 x 70 mm  
Gross Product Weight 25 gr

## Protection

Enclosure protection class IP 54  
CE Compliance YES

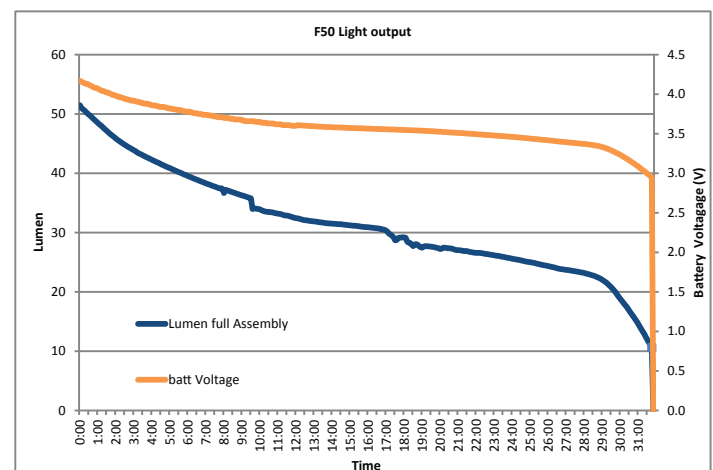

# JouleStick30

Product Specifications  
PS-JS30-01/01-170616

The JouleStick30 is a lithium-Ion energy storage device with build in electronic circuit to protect against over-charge, over-discharge and short circuit. The electrical contacts of the JouleStick are goldplated to ensure a low contact resistance and a long life of the mechanical connection. The JouleStick has an expected life of over 30MJ of energy delivery which translates in approximately 2000 charge/discharge cycles of about 15kj per cycle or 1500 charge/discharge cycles of 20kj per cycle.



## Product HighLights

- The JouleStick30 contains 30kj of energy
- Fully charges a smart phone or 2 low feature phones
- Up to 60 hours on a full charge (Lowest light output of F200T)
- Recharged via the PicoLEC20 Solar Panel or via a phonestick and USB port
- Splash-Waterproof and is suitable for outdoor usage even in the rain
- Electrical contacts are completely sealed and no water can leak through the contacts to the inside of the lamp that houses the battery and electronic circuit.



Refill your JouleStick30 from the sun



Refill your Phone from the JouleStick30



Use your JouleStick30 as Table Lamp

## JouleStick30 Performance

Energy Storage Capacity	30 kj
Aproximale lifetime energy	30 MJ

## Charging details

Max Charging Capacity (per hour)	30 kj/h
Max Charging Capacity (per second)	10 J/s (W)
Max Charge Current	2 A
Charging Operating Temperature	0°C to 45°C

## Discharging details

Max Discharging Capacity (per hour)	30 kj/h
Max Discharging Capacity (per second)	10 J/s (W)
Max Discharging Current	2 A
Output Voltage Range	3.0 - 4.2 VDC
Charging Operating Temperature	20°C to 60°C

## Mechanical Details

Connector System	Pogopin
Enclosure Material	ABS + UV Stabilized
Color	Blue
Product Dimension (DxH)	22 x 72 mm
Product Dimension with Sleeve (DxH)	27 x 80 mm
Nett Product Weight	50 gr
Product Weight with Sleeve	61 gr
Packaging Options	Individual Packing or as part of JouleStick kits
Individual Box Dimension	30 x 30 x 115 mm
Gross Product Weight	71 gr

## Protections

Protection on Inputs	Over Voltage Cut-off Over current Protection
Protection on 12-16 V Outputs	Under Voltage Cut-off Over Load Protection Short Circuit Protection

# PicoLEC20

Product Specifications  
PS-LEC600-01/01-210616

The LEC20 can harvest approximately 20kj (5.6 Wh) of energy per day when parked in full sunlight without being obstructed by shadow. During a very bright day the output can be up to 30kj (8.3Wh). During a cloudy day and obstructions by shadow the energy output could be reduced to only 10kj (2.8Wh) or less. In order to get the maximum energy harvest ensure that you put out the LEC20 in full sunshine as early in the morning as possible and direct the panel surface under straight angle facing the sun's rays.



The LEC20 is made of highly durable material and when used correctly the life of this product can reach over 20 years.

## General

Product Name	Photovoltaic Module (PV Module)
Product Type	PicoLEC20
Product Description	High Efficiency Multi Crystalline Photovoltaic Module for solar home system applications

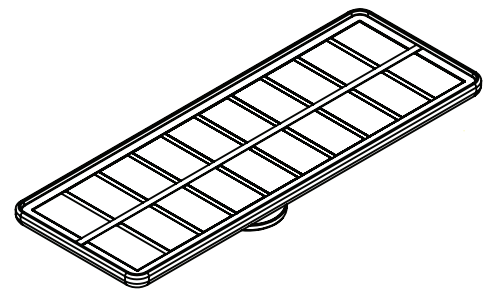

## Electrical Details

Electricity Generation Capacity	20 kJoule/day @ 5.5 Sun Hours
Maximum Energy Rating (Pmax)	1.3 Wp
Tolerance	+/- 10%
Cell Efficiency	+/- 17%
FF	+/- 71%
Total Cell	10 Cell
Maximum Power Voltage (Vmp)	4.86 V
Maximum Power Current (Imp)	0.27 A
Open Circuit Voltage (Voc)	5.38 V
Short-Circuit Current (Isc)	0.29 A

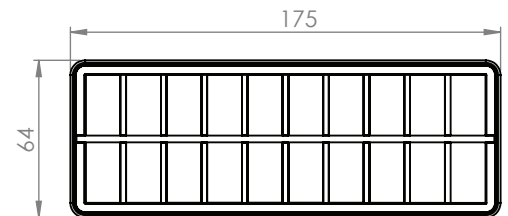

## Thermal Parameters

Nominal Operating Cell Temperature	40°C to 90°C
Isc Current Temperature Coefficient	(1.33 x 0.001) A/°C
Voc Voltage Temperature Coefficient	(-8.21 x 0.01) V/°C

Note: The electrical specifications are under test conditions of Irradiance of 1kW/m<sup>2</sup>, spectrum of 1.5 air mass and cell temperature of 25°C

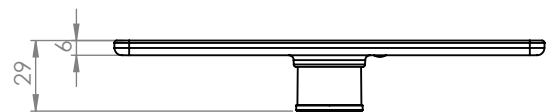

## Mechanical Details

Frame Materials	ABS + UV Stabilized
Product Dimensions (LxWxH)	175 x 64 x 29 mm
Nett Product Weight	100 gr
Packaging Options	Individual Packing or as part of JouleStick kits
Individual Box Dimension	212 x 65 x 30 mm
Gross Weight	117 gr

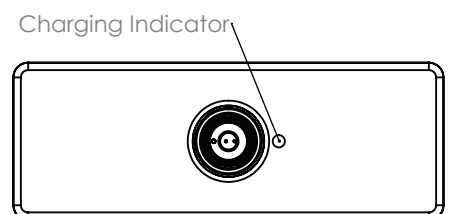

# PhoneStick

## Product Specifications

PS-PhoneStick-01/01-230616

The **PhoneStick** is multifunctional charger that can be directly connected to JouleStick.

The **Phonestick** can charge any device that can be charged from a USB standard socket and it also can be used to energize small radio or cassette player with a rated voltage of 3 to 4.2 VDC.

The Charger can supply to maximum of 1000 mA current and is protected for short circuit and overload.



### Electrical details

Rated Input Voltage	3 - 4.2 VDC
Nominal Output Voltage	5 V
Maximum Input Current	1000 mA
Maximum Output Current	1000 mA
Electrical Efficiency	95%
Enclosure Protection Class	IP 22

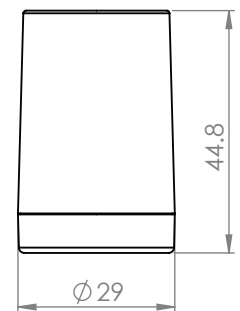

### Mechanical details

Operating Temperature Range	-10 C to + 55 C
Enclosure Material	ABS + UV Stabilized
Connector Material	Brass str
Product Dimensions (L x Dia.mm)	44.8 x 29 mm
Nett Product Weight	15.5 gr

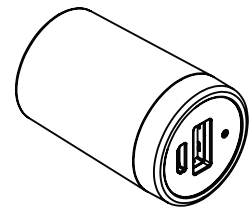

### Protection

Short Circuit Protection	Yes
Over Load Protection	Yes

